

MENNEKES
 Electrical Products
 277 Fairfield Road
 Fairfield, NJ 07004
 800-882-7584
 www.MENNEKES.com

SPEC GRADE STAINLESS DISCONNECT SWITCH

Part No.	ME 20SLP2A-M2
Description:	25 Amp 3Ø 600Vac Motor Disconnect with Early Break Aux Contacts - 1 N/O; 1 N/C
Construction:	NEMA 4X; 12
Compliance:	UL Standard 508 and CSA C22.2 No.14-10; UL 50E
Performance:	Lock Rotor Tested 10kAIC with 45A RK1 Fuse Suitable as Motor Disconnect Per NEC 430-109 (a)(6)

HP RATINGS:

1 Ø		3 Ø	
240V	480/600V	240V	480/600V
1.5	3	3	5

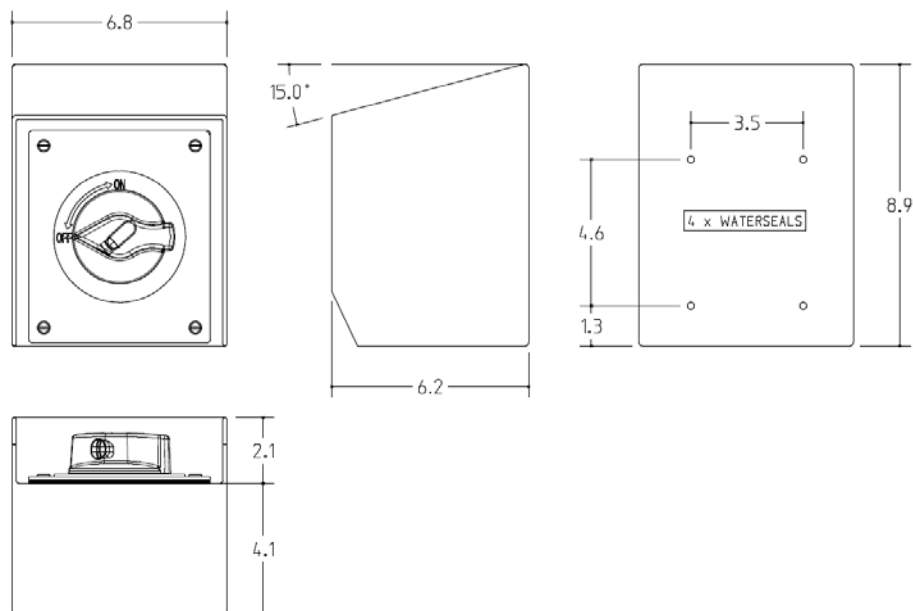

Drawing Not to Scale